

# JVC



## COMPACT COMPONENT SYSTEM

# FS-H100

—Consists of CA-FSH100 and SP-FSH100

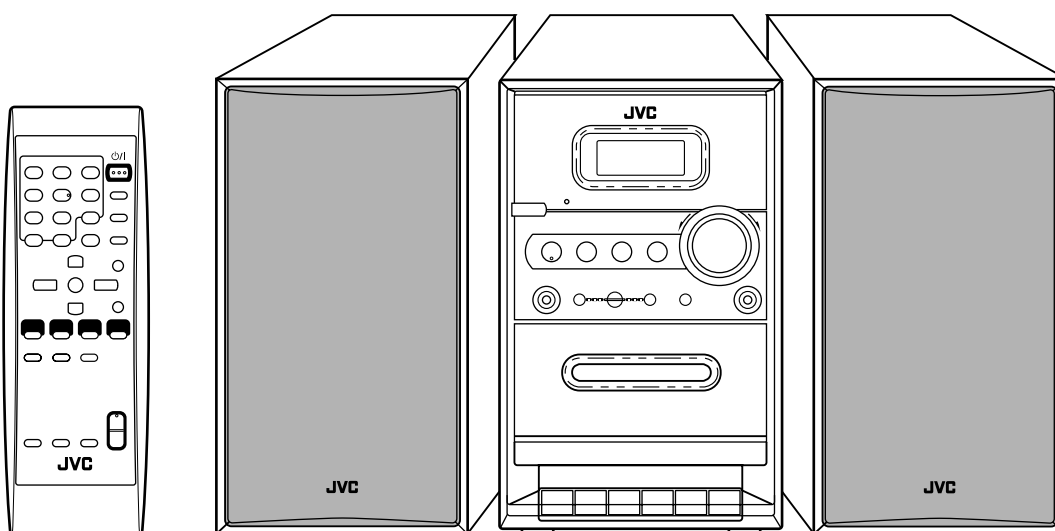

COMPACT  
**disc**  
DIGITAL AUDIO

**MP3**  
**PLAYBACK**

## INSTRUCTIONS

**For Customer Use:**

Enter below the Model No. and Serial No. which are located either on the rear, bottom or side of the cabinet. Retain this information for future reference.

Model No. \_\_\_\_\_

Serial No. \_\_\_\_\_

## Warnings, Cautions and Others

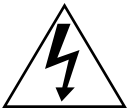

The lightning flash with arrowhead symbol, within an equilateral triangle is intended to alert the user to the presence of uninsulated "dangerous voltage" within the product's enclosure that may be of sufficient magnitude to constitute a risk of electric shock to persons.



The exclamation point within an equilateral triangle is intended to alert the user to the presence of important operating and maintenance (servicing) instructions in the literature accompanying the appliance.

### For U.S.A.

This equipment has been tested and found to comply with the limits for a Class B digital device, pursuant to part 15 of the FCC Rules. These limits are designed to provide reasonable protection against harmful interference in a residential installation.

This equipment generates, uses and can radiate radio frequency energy and, if not installed and used in accordance with the instructions, may cause harmful interference to radio communications. However, there is no guarantee that interference will not occur in a particular installation. If this equipment does cause harmful interference to radio or television reception, which can be determined by turning the equipment off and on, the user is encouraged to try to correct the interference by one or more of the following measures:

- Reorient or relocate the receiving antenna.
- Increase the separation between the equipment and receiver.
- Connect the equipment into an outlet on a circuit different from that to which the receiver is connected.
- Consult the dealer or an experienced radio/TV technician for help.

**WARNING: TO REDUCE THE RISK OF FIRE OR ELECTRIC SHOCK, DO NOT EXPOSE THIS APPLIANCE TO RAIN OR MOISTURE.**

### CAUTION—/I STANDBY/ON button!

Disconnect the mains plug to shut the power off completely (all lamps and indications go off). The /I STANDBY/ON button in any position does not disconnect the mains line.

- When the unit is on standby, the STANDBY lamp lights red.
- When the unit is turned on, the STANDBY lamp goes off.

The power can be remote controlled.

### CAUTION

To reduce the risk of electrical shocks, fire, etc.:

1. Do not remove screws, covers or cabinet.
2. Do not expose this appliance to rain or moisture.

### For Canada/pour le Canada

**CAUTION:** TO PREVENT ELECTRIC SHOCK, MATCH WIDE BLADE OF PLUG TO WIDE SLOT, FULLY INSERT.

**ATTENTION:** POUR EVITER LES CHOCS ELECTRIQUES, INTRODUIRE LA LAME LA PLUS LARGE DE LA FICHE DANS LA BORNE CORRESPONDANTE DE LA PRISE ET POUSSER JUSQU'AU FOND.

### For Canada/pour le Canada

THIS DIGITAL APPARATUS DOES NOT EXCEED THE CLASS B LIMITS FOR RADIO NOISE EMISSIONS FROM DIGITAL APPARATUS AS SET OUT IN THE INTERFERENCE-CAUSING EQUIPMENT STANDARD ENTITLED "DIGITAL APPARATUS," ICES-003 OF THE DEPARTMENT OF COMMUNICATIONS.

CET APPAREIL NUMERIQUE RESPECTE LES LIMITES DE BRUITS RADIOELECTRIQUES APPLICABLES AUX APPAREILS NUMERIQUES DE CLASSE B PRESCRITES DANS LA NORME SUR LE MATERIEL BROUILLEUR: "APPAREILS NUMERIQUES", NMB-003 EDICTEE PAR LE MINISTRE DES COMMUNICATIONS.

### CAUTION: Proper Ventilation

To avoid risk of electric shock and fire, and to prevent damage, locate the apparatus as follows:

#### 1 Front:

No obstructions and open spacing.

#### 2 Sides/ Top/ Back:

No obstructions should be placed in the areas shown by the dimensions below.

#### 3 Bottom:

Place on the level surface. Maintain an adequate air path for ventilation by placing on a stand with a height of 10 cm or more.

#### Front view

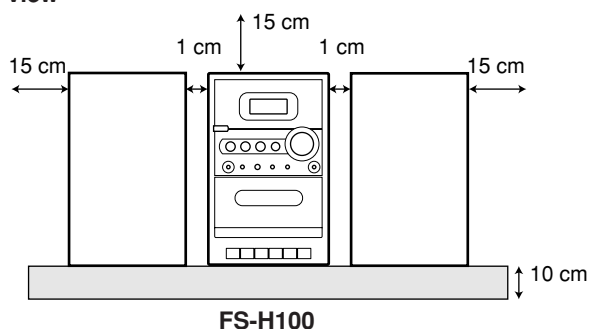

#### Side view

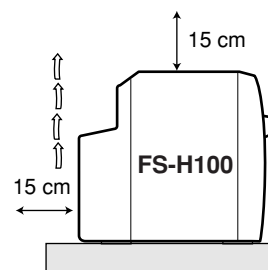

# Contents

---

<b>Introduction .....</b>	<b>2</b>
<b>Location of the Buttons and Controls .....</b>	<b>3</b>
Main Unit .....	3
Remote Control .....	5
<b>Getting Started .....</b>	<b>6</b>
Unpacking .....	6
Putting the Batteries into the Remote Control .....	6
Connections .....	6
Connecting Other Equipment .....	7
<b>Basic and Common Operations .....</b>	<b>8</b>
Setting the Clock .....	8
Turning On the Power .....	8
Selecting the Source .....	9
Adjusting the Volume .....	9
Fade Muting .....	9
Selecting the Sound Modes .....	9
Adjusting the Tone (Bass/Treble) .....	9
<b>Listening to FM and AM Broadcasts.....</b>	<b>10</b>
Tuning in to a Station .....	10
Presetting Stations .....	10
Tuning in to a Preset Station .....	11
<b>Playing Back Discs .....</b>	<b>12</b>
Playing Back the Entire Disc—Normal Play .....	12
Basic Disc Operations .....	13
Programming the Track Playing Order—Program Play .....	13
Repeating Tracks—Repeat Play .....	14
Playing at Random—Random Play .....	14
Displaying the Remaining Time during Playback .....	14
<b>Playing Back Tapes.....</b>	<b>15</b>
Playing Back a Tape .....	15
<b>Using an External Equipment .....</b>	<b>16</b>
Listening to the External Equipment .....	16
<b>Recording .....</b>	<b>17</b>
Recording on a Tape .....	17
Recording Discs—Disc Synchronized Recording .....	18
<b>Using the Timers .....</b>	<b>19</b>
Using the Daily Timer .....	19
Using the Sleep Timer .....	20
<b>Maintenance.....</b>	<b>21</b>
<b>Troubleshooting .....</b>	<b>22</b>
<b>Specifications .....</b>	<b>23</b>

# Introduction

---

We would like to thank you for purchasing one of our JVC products. Before operating this unit, read this manual carefully and thoroughly to obtain the best possible performance from your unit, and retain this manual for future reference.

## About This Manual

---

This manual is organized as follows:

- This manual mainly explains operations using the buttons on the remote control. You can use the buttons both on the remote control and on the unit for the same operations if they have the same or similar names (or marks), unless mentioned otherwise.
- Basic and common information that is the same for many functions is grouped in one place, and is not repeated for each procedure. For instance, we do not repeat the information about turning on/off the unit, setting the volume, changing the sound effects, and others, which are explained in the section “Basic and Common Operations” on pages 8 and 9.
- The following symbols are used in this manual:



Gives you warning and caution to prevent damage or risk of fire/electric shock. In addition, we put information here about conditions which will prevent getting the best possible performance from the unit.



Gives you information and hints you need to know.

## Precautions

---

### Installation

- Install in a place which is level, dry and neither too hot nor too cold—between 5°C (41°F) and 35°C (95°F).
- Install the unit in a location with adequate ventilation to prevent internal heat buildup.
- Leave sufficient distance between the unit and the TV.
- Keep the speakers away from the TV to avoid interference with TV.



DO NOT install the unit in a location near heat sources, or in a place subject to direct sunlight, excessive dust or vibration.

### Power sources

- When unplugging the unit from the wall outlet, always pull on the plug, not the AC power cord.



DO NOT handle the AC power cord with wet hands.

### Moisture condensation

Moisture may condense on the lenses inside the unit in the following cases:

- After starting to heat the room.
  - In a damp room.
  - If the unit is brought directly from a cold to a warm place.
- Should this occur, the unit may malfunction. In this case, leave the unit turned on for a few hours until the moisture evaporates, unplug the AC power cord, then plug it in again.

### Others

- Should any metallic object or liquid fall into the unit, unplug the AC power cord and consult your dealer before operating any further.
- If you are not going to operate the unit for an extended period of time, unplug the AC power cord from the wall outlet.



DO NOT disassemble the unit since there are no user serviceable parts inside.

If anything goes wrong, unplug the AC power cord and consult your dealer.

# Location of the Buttons and Controls

Continued 

Become familiar with the buttons and controls on your unit.

## Main Unit

Top view

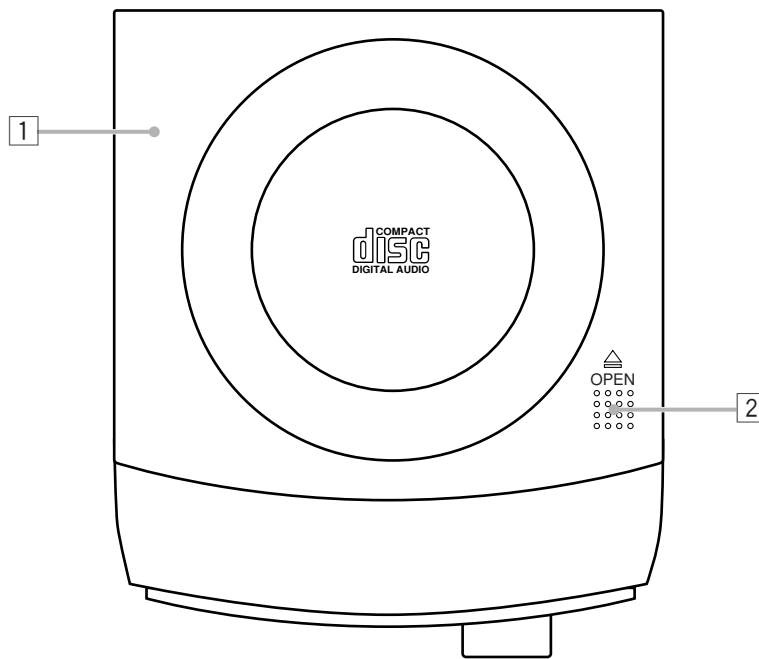

Front view

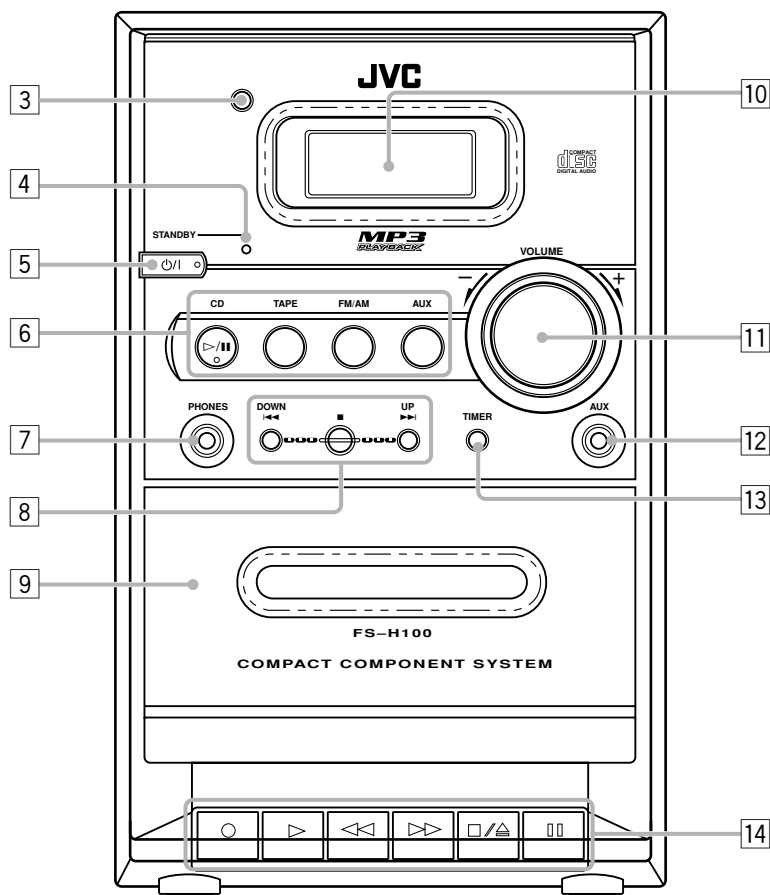

# Location of the Buttons and Controls (continued)

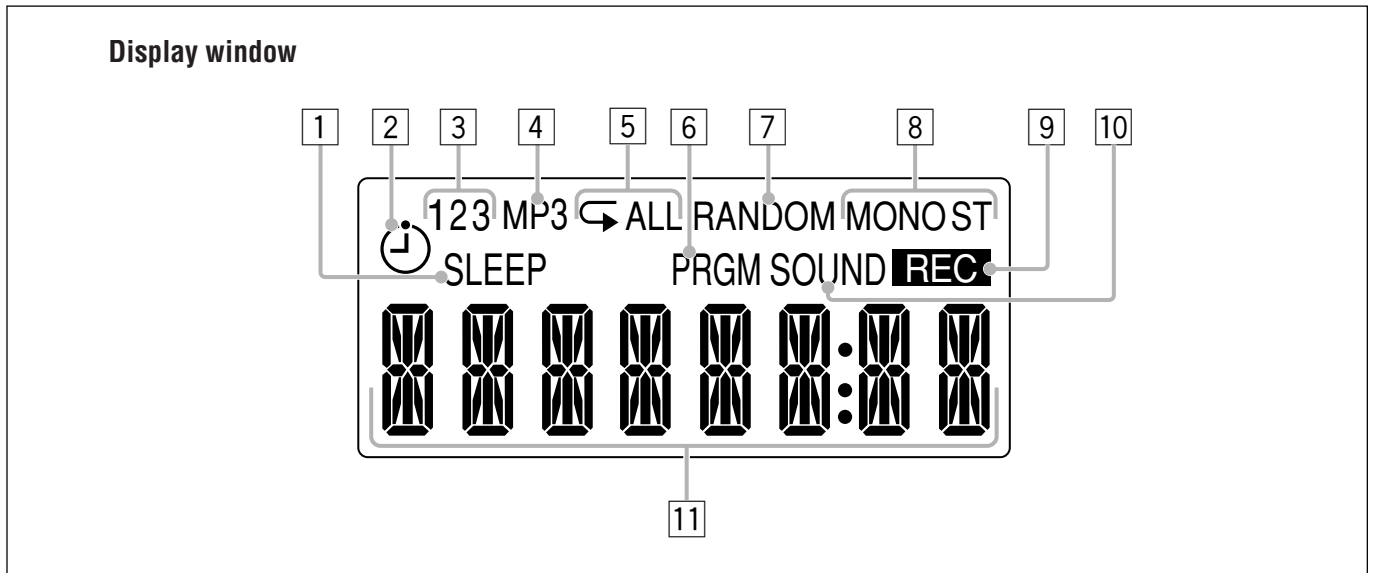

See pages in parentheses for details.

## Main unit

- 1 Disc cover (12)
- 2 ▲ OPEN (disc cover open) (12)
- 3 Remote sensor (5)
- 4 STANDBY lamp (8)
- 5 ⏻/⏻ (STANDBY/ON) button (8, 19)
- 6 Source buttons
  - CD ▷/⏻, TAPE, FM/AM, AUX*Pressing one of these buttons also turns on the unit.*
- 7 PHONES jack (9)
- 8 MULTI CONTROL buttons
  - DOWN ◀◀, ■, UP ▶▶
- 9 Cassette holder (15)
- 10 Display window
- 11 VOLUME control (9)
- 12 AUX jack (7, 17)
- 13 TIMER button (20)
- 14 Tape operation buttons (15, 17)
  - ○ (recording), ▷ (play), ◀◀ (fast backward), ▶▶ (fast forward), ◻/⏻ (stop/cassette holder open), ◻◻ (pause)

## Display window

- 1 SLEEP indicator
- 2 ⌚ (timer) indicator
- 3 Timer number indicator
- 4 MP3 indicator
- 5 Repeat indicators
  - ↶, ↷, ALL
- 6 PRGM (program) indicator
- 7 RANDOM indicator
- 8 FM mode indicators
  - MONO, ST (stereo)
- 9 REC indicator
- 10 SOUND indicator
- 11 Main display

## Remote Control

See pages in parentheses for details.

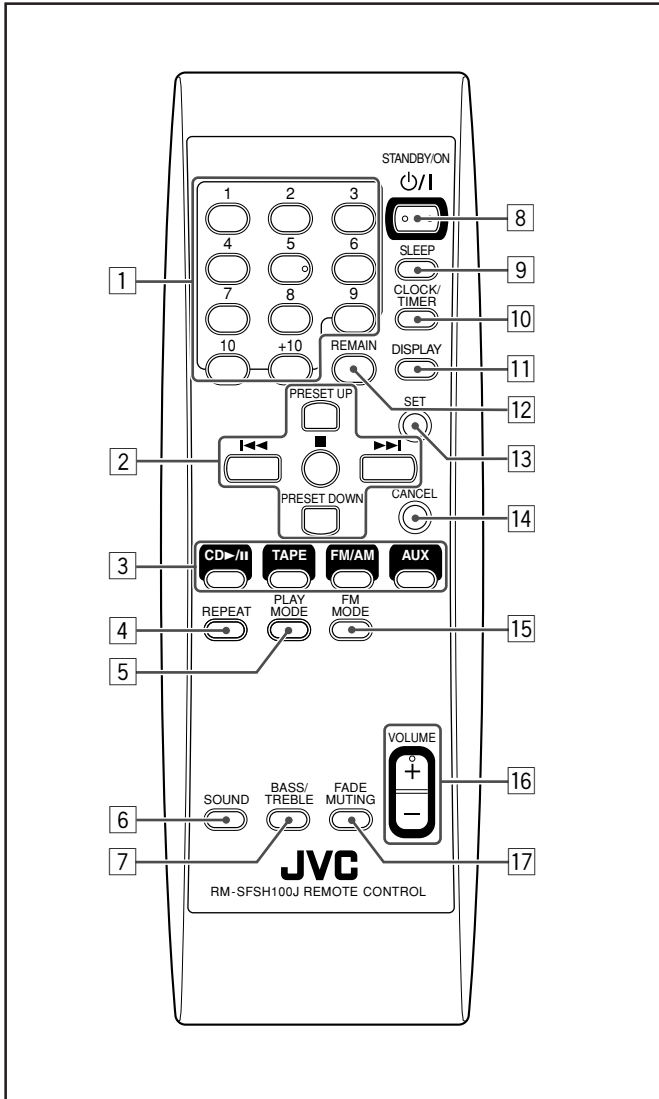

- 1 Number buttons (10, 11, 13)
- 2 Multi control buttons
  - PRESET UP, PRESET DOWN
  - ◀◀, ■, ▶▶
- 3 Source buttons
  - CD ▷/||, TAPE, FM/AM, AUX

*Pressing one of these buttons also turns on the unit.*
- 4 REPEAT button (14)
- 5 PLAY MODE button (10, 13, 14)
- 6 SOUND button (9)
- 7 BASS/TREBLE button (9)
- 8 STANDBY/ON ⏻/⏻ button (8, 19)
- 9 SLEEP button (20)
- 10 CLOCK/TIMER button (8, 19)
- 11 DISPLAY button (8)
- 12 REMAIN button (14)
- 13 SET button (8, 19)
- 14 CANCEL button (20)
- 15 FM MODE button (10)
- 16 VOLUME + / - buttons (9)
- 17 FADE MUTING button (9)

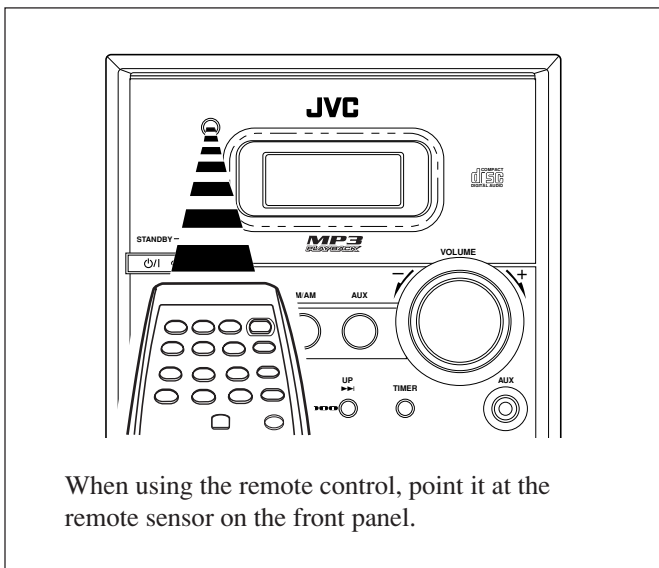

When using the remote control, point it at the remote sensor on the front panel.

# Getting Started

## Unpacking

After unpacking, check to be sure that you have all the following items.

The number in parentheses indicates the quantity of each piece supplied.

- AM loop antenna (1)
- Remote control (1)
- Batteries (2)

If any item is missing, consult your dealer immediately.

## Putting the Batteries into the Remote Control

Insert the batteries—R6(SUM-3)/AA(15F)—into the remote control by matching the polarity (+ and -) on the batteries with the + and - marking on the battery compartment. When the remote control can no longer operate the unit, replace both batteries at the same time.

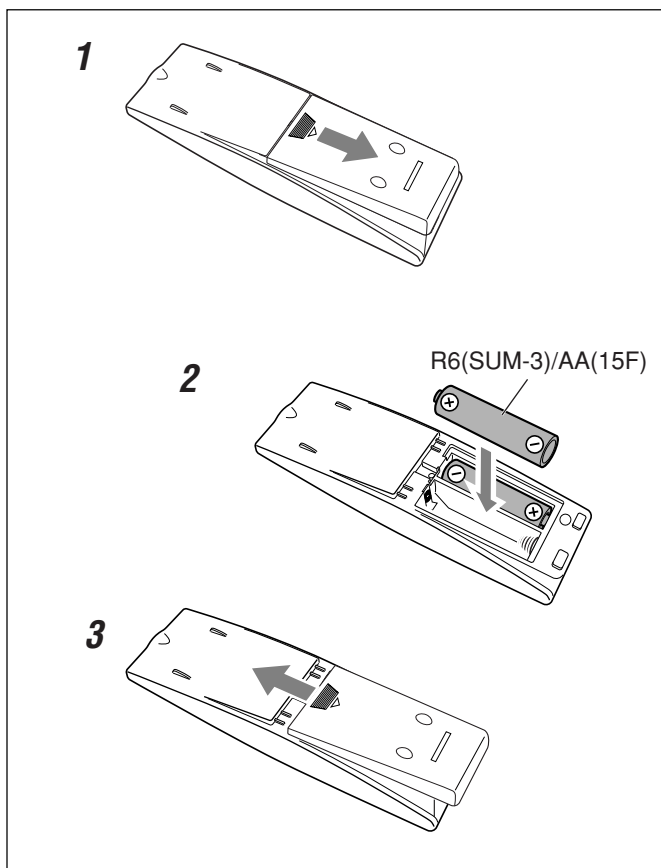

- DO NOT use an old battery together with a new one.
- DO NOT use different types of batteries together.
- DO NOT expose batteries to heat or flame.
- DO NOT leave the batteries in the battery compartment when you are not going to use the remote control for an extended period of time. Otherwise, the remote control will be damaged from battery leakage.

## Connections

### To connect speakers

You can connect the speakers using the speaker cords.

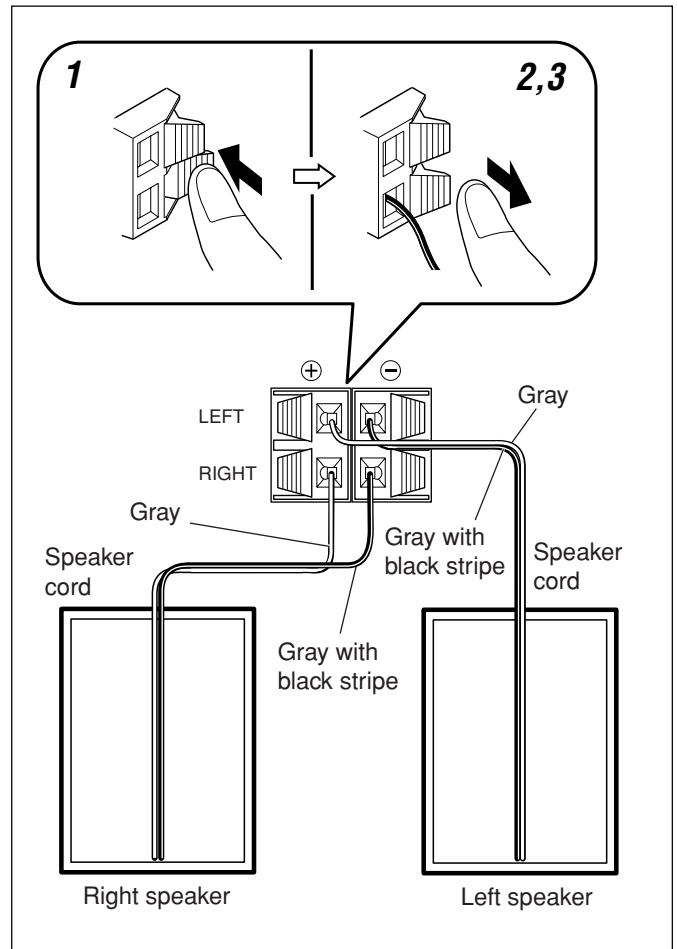

**1 Hold the clamp of the speaker terminal.**

**2 Insert the end of the speaker cord into the terminal.**

Match the polarity of the speaker terminals: gray cord (⊕) to red (⊕) and gray cord with black stripe (⊖) to black (⊖).

**3 Release your finger from the clamp.**

#### IMPORTANT:

- Use only speakers with the same speaker impedance as indicated by the speaker terminals on the rear of the unit.
- DO NOT connect more than one speaker to one speaker terminal.



## To connect AM and FM antennas

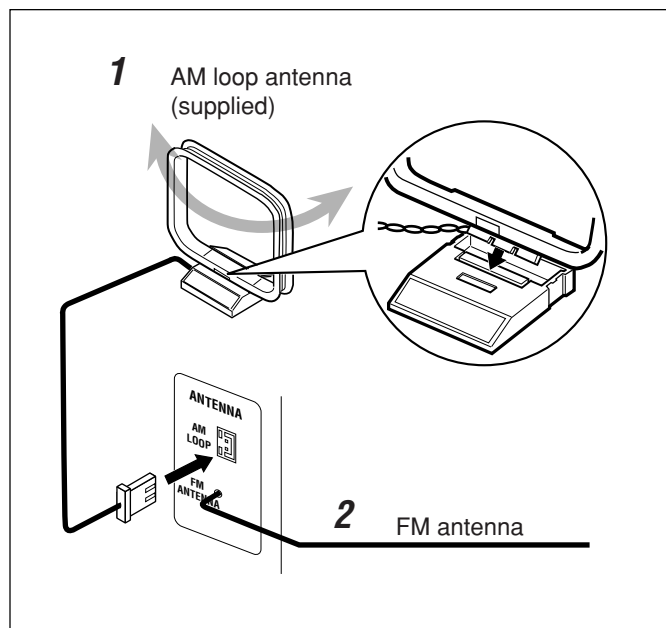

### 1 Connect the supplied AM loop antenna to the AM LOOP terminal.

Place the antenna away from the unit and adjust its position for the best reception.

### 2 Adjust the position for the FM antenna for the best reception.



#### For better reception of both FM and AM

- Make sure the antenna conductors do not touch any other terminals or connecting cords.
- Keep the antennas away from metallic parts of the unit, connecting cords, and the AC power cord.

## Connecting Other Equipment

### To connect audio equipment

You can connect audio equipment—used only as a playback device.



- DO NOT connect any equipment while the power is on.
- DO NOT plug in any equipment until all connections are complete.

For playing other equipment through this unit, connect between the audio output jacks on the other equipment and AUX jacks by using audio cords with mini plugs (not supplied).

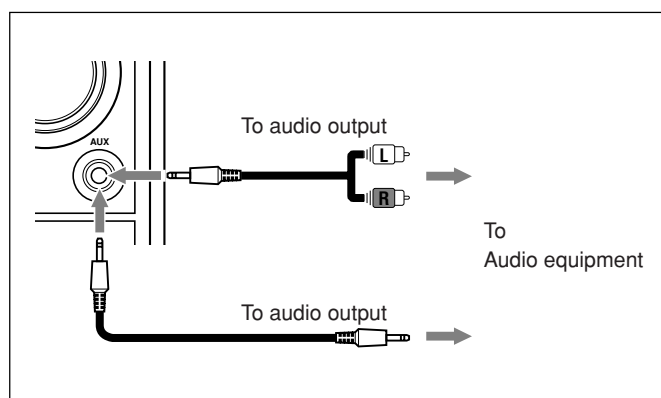

When the audio equipment has pin jacks for audio output: Be sure that the pin plugs of the audio cords are colored—white plugs and jacks are for left audio signals, and red ones for right audio signals.

## NOW you are ready to plug in the unit.

### IMPORTANT:

Be sure to check that all connections have been made before plugging in the power cord.

# Basic and Common Operations

## Setting the Clock

Before operating the unit any further, first set the unit's clock. When you plug in the power cord, "AM12:00" starts flashing on the display.

You can set the clock when the unit is either turned on or in standby mode.

### On the remote control ONLY:

#### 1 Press CLOCK/TIMER.

The hour indication starts flashing.



#### 2 Press ◀◀ or ▶▶ to adjust the hour, then press SET.

- When you press and hold ◀◀ or ▶▶, the hour indication changes continuously.

The minute indication starts flashing.



#### 3 Press ◀◀ or ▶▶ to adjust the minute, then press SET.

- When you press and hold ◀◀ or ▶▶, the minute indication changes continuously.

The built-in clock starts.

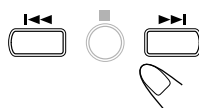

- When you unplug the AC power cord or if a power failure occurs**  
The clock is reset to "AM12:00" right away. If this happens, set the clock again.
- The clock may gain or lose 1 to 2 minutes per month**  
If this happens, reset the clock.

To show the clock when the unit is turned on

### On the remote control ONLY:

Press DISPLAY.

- Each time you press the button, the display changes the clock indication and the normal indication alternately.



To adjust the clock

### On the remote control ONLY:

#### 1 Press CLOCK/TIMER repeatedly to show the current time indication.

#### 2 Press SET.

The hour indication starts flashing.

#### 3 Press ◀◀ or ▶▶ to adjust the hour, then press SET.

The minute indication starts flashing.

#### 4 Press ◀◀ or ▶▶ to adjust the minute, then press SET.

The built-in clock starts.

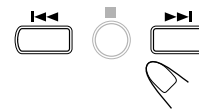

## Turning On the Power

To turn on the unit, press STANDBY/ON .

The STANDBY lamp on the unit goes off.

- When you press the source button—CD , TAPE, FM/AM and AUX, the unit automatically turns on.



To turn off the unit (standby), press STANDBY/ON  again.

The STANDBY lamp on the unit lights red.

- "AM12:00" flashes on the display until you set the built-in clock. After setting the clock, the clock time will appear on the display while the unit is on standby.
- A little power is always consumed even while the unit is in standby mode.

To switch off the power supply completely, unplug the AC power cord from the AC outlet.



**When you unplug the AC power cord or if a power failure occurs**

The clock is reset to "AM12:00" right away and "AM12:00" starts flashing on the display when plugging the power cord again. If this happens, set the clock again.

## Selecting the Source

To select the source, press CD ►/II, TAPE, FM/AM, or AUX.

- When you select CD as the source, playback starts automatically.

To operate the tuner (FM or AM), see pages 10 and 11.

To operate the CD player, see pages 12 to 14.

To operate the tape deck, see page 15.

To record on a tape, see pages 17 and 18.

To use an external equipment, see page 16.

## Adjusting the Volume

You can adjust the volume level only while the unit is turned on. The volume level can be adjusted between “VOL MIN,” “VOL 01” – “VOL 30,” and “VOL MAX.”

- The volume level has no effect on recording.

To increase the volume, press VOLUME + (or turn VOLUME control clockwise on the unit).

To decrease the volume, press VOLUME – (or turn VOLUME control counterclockwise on the unit).

- When you press and hold either button, you can change the volume level continuously.



### For private listening

Connect a pair of headphones to the PHONES jack. No sound comes out of the speakers. Be sure to turn down the volume before connecting or putting on the headphones.



DO NOT turn off (standby) the unit with the volume set to an extremely high level; otherwise, the sudden blast of sound can damage your hearing, speakers and/or headphones when you turn on the unit or start playing any source. REMEMBER you cannot adjust the volume level while the unit is in standby mode.

## Fade Muting

### On the remote control ONLY:

Press FADE MUTING.

The volume level decreases to “VOL MIN,” and “MUTING” starts flashing on the display.



To release muting, press FADE MUTING again. The volume level resumes to the previous level.

- Adjusting the volume level also cancels the muting.

## Selecting the Sound Modes

You can select one of the 4 sound modes.

- This function also affects the sound from headphones.
- This function only affects the playback sound, and does not affect your recording.

### On the remote control ONLY:

To select the sound modes, press SOUND repeatedly.



- Each time you press the button, the sound mode changes as follows:



**ROCK:** Powerful sound emphasizing treble and bass.

**POP:** More presence in the vocals and midrange.

**CLASSIC:** Enriched sound with fine treble and ample bass.

**JAZZ:** Accented lower frequencies for jazz-type music.

**OFF:** Equalizer effect is canceled.



When the sound mode is activated, the SOUND indicator lights up on the display.

## Adjusting the Tone (Bass/Treble)

You can adjust the bass level (low frequency range) and the treble level (high frequency range) within a range of –1 to +4. When shipped, the bass level set to “BASS 0” and the treble level set to “TREBLE 0.”

- This function only affects the playback sound, and does not affect your recording.
- There is a time limit in doing the following steps. If the setting is canceled before you finish, start over from step 1.

### On the remote control ONLY:

**1** Press BASS/TREBLE once to adjust the bass level or press BASS/TREBLE twice to adjust the treble level.



**2** Press PRESET UP to increase the level or press PRESET DOWN to decrease it.



- You cannot use the tone adjustment function and the sound mode function at the same time. (The sound mode changes automatically into “OFF” when pressing BASS/TREBLE.)
- The bass/treble setting automatically returns to “0” when you select one of the sound modes (see “Selecting the Sound Modes” above).

# Listening to FM and AM Broadcasts

## Tuning in to a Station

**1** Press FM/AM to select either “FM” or “AM.”



The unit automatically turns on and tunes in to the previously received station—either FM or AM.

- Each time you press the button, the band alternates between FM and AM.



**2** Press and hold **▶▶▶** or **◀◀◀** (or **UP ▶▶▶** or **DOWN ◀◀◀** on the unit) for more than 1 second.

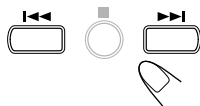

- **▶▶▶** (UP **▶▶▶**): Increases the frequencies.
- **◀◀◀** (DOWN **◀◀◀**): Decreases the frequencies.

The unit starts searching for stations and stops when a station of sufficient signal strength is tuned in.

- If an FM program is broadcast in stereo, the ST (stereo) indicator lights up on the display (only when the reception is good).

To stop during searching, press **▶▶▶** or **◀◀◀** (or **UP ▶▶▶** or **DOWN ◀◀◀** on the unit).



**When you repeatedly press **▶▶▶** or **◀◀◀** (or **UP ▶▶▶** or **DOWN ◀◀◀** on the unit)**

The frequency changes step by step.

### To change the FM reception mode

#### On the remote control ONLY:

When an FM stereo broadcast is hard to receive or noisy, press FM MODE so that the MONO indicator lights up on the display. Reception will improve.

To restore the stereo effect, press FM MODE again so that the MONO indicator goes off. In stereo mode, you can hear stereo sound when a stereo program is broadcast.

## Presetting Stations

You can preset 30 FM and 15 AM stations manually.

In some cases, test frequencies have been already stored for the tuner since the factory examined the tuner preset function before shipment. This is not a malfunction. You can preset the stations you want into memory by following the presetting method.

- There is a time limit in doing the following steps. If the setting is canceled before you finish, start again from step 2.

## On the remote control ONLY:

**1** Tune in to the station you want to preset.

- See “Tuning in to a Station” on the left column.

**2** Press **PLAY MODE**.

The preset number starts flashing on the display.

- The PRGM (program) indicator lights up on the display.

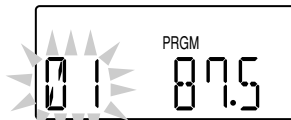

**3** Press **▶▶▶** or **◀◀◀** to select a preset number.

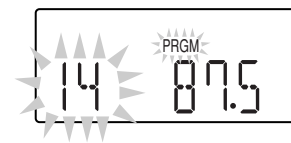
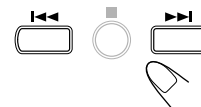

You can also use the number button(s) to select a preset number.

Ex.: To select a preset number 5, press 5.

To select a preset number 15, press +10, then 5.

To select a preset number 20, press +10, then 10.

To select a preset number 30, press +10, +10, then 10.

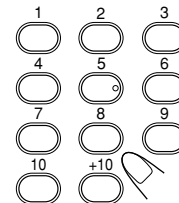

**4** Press **PLAY MODE** again.



**5** To preset more stations, repeat steps 1 to 4 above, allocating a different preset number to each station.

- Storing a new station on an already assigned number erases the previously stored one.



**When you unplug the AC power cord or if a power failure occurs**

The preset stations will remain in the unit.

---

## Tuning in to a Preset Station

---

### On the remote control ONLY:

**1** Press FM/AM to select either “FM” or “AM.”



The unit automatically turns on and tunes in to the previously received station—either FM or AM.

- Each time you press the button, the band alternates between FM and AM.

**2** Press PRESET UP or PRESET DOWN repeatedly to select a preset number.



To tune in to a preset station directly using the number buttons

### On the remote control ONLY:

Pressing the number button(s) allows you to select the preset number you want.

Ex.: For preset number 5, press 5.

For preset number 15, press +10, then 5.

For preset number 20, press +10, then 10.

For preset number 30, press +10, +10, then 10.

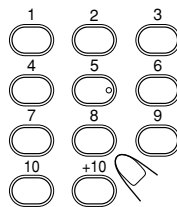

# Playing Back Discs

This unit has been designed to play back the following discs—CD, CD-R, and CD-RW.

You can play back the discs containing the tracks in music CD format or MP3 files in ISO 9660 format.

- In this instruction, we call a disc recorded MP3 files “MP3 disc,” and “file” is also referred to as “track.”

## When playing CD-Rs or CD-RWs

- Before playing CD-Rs or CD-RWs, read their instructions or cautions carefully.
- User-edited CD-Rs (CD-Recordable) and CD-RWs (CD-ReWritable) can be played only if they are already “finalized.”
- This unit supports “multi-session” discs (up to 5 sessions).
- This unit cannot play “packet write” discs.
- Some CD-Rs or CD-RWs may not play on this unit because of their disc characteristics, damage or stain on them, or if the player’s lens is dirty.
- CD-RWs may require a longer readout time. This is because the reflectance of CD-RWs is lower than for regular discs.

## Notes for MP3 files

- The player can only recognize files with “MP3” or “mp3” as the extensions, which can be in any combination of upper and lower case.
- This unit recognizes up to 500 MP3 files on a disc.
- It is recommended that you record your material at a 44.1 kHz sampling rate, using the 128 kbps data transfer rate.
- Some MP3 files or discs may not be played back because of their characteristics or recording conditions.
- MP3 discs requires a longer readout time than normal discs because of the complexity of the folder/file configuration.
- ID 3 Tag is not available.
- MP3i and MP3 Pro are not available.

## General notes

- In general, you will have the best performance by keeping your discs and the mechanism clean.
- Store discs in their cases, and keep them in cabinets or on shelves.
  - Keep the unit’s disc trays closed when not in use.
  - Continued use of irregular shape discs (heart-shape, octagonal, etc.) can damage the unit.



## Playing Back the Entire Disc—Normal Play

### 1 Press ▲ OPEN on the unit.

The disc cover opens.

- You can insert a disc while listening to another source.

**2 Place a disc correctly with its label side up, then press down on the portions around the disc’s center hole until you hear a click.**

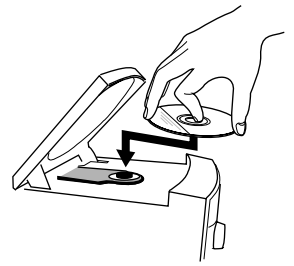

**3 Close the disc cover gently.**

**4 Press CD ►/II.**

The unit automatically turns on and the source changes to the CD player. After loading the disc, the first track of the disc starts playing.



### When playing audio CD

Current track number



Elapsed playing time

### When playing MP3 disc

MP3 indicator

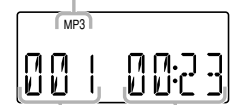

Current track number

Elapsed playing time

- The disc automatically stops when the last track has finished playing.

**To stop playing, press ■.**

The total track number and total playing time appear on the display.



### When stop playing audio CD

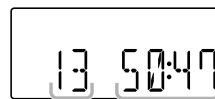

Total track number

Total playing time

### When stop playing MP3 disc

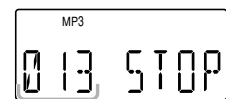

Total track number

- Total playing time does not appear when MP3 disc is loaded.

**To remove the disc, press ▲ OPEN on the unit, then take out the disc by holding it at the edges while pressing the unit’s pivot lightly.**



- If the disc cannot be read correctly (because it is scratched, for example) or an unreadable CD-R or CD-RW is inserted Playback will not start.
- If no disc is inserted “NO DISC” appears on the display.



DO NOT try to open the disc cover by hand as it will be damaged.

## Basic Disc Operations

While playing a disc, you can do the following operations.

### To stop playing for a moment

During play, press CD ►/||.

While pausing, the elapsed playing time flashes on the display.



To resume playing, press CD ►/|| again.

### To go to another track

Before or during play, press ►►| or |◄◄ (or UP ►►| or DOWN |◄◄ on the unit) repeatedly.

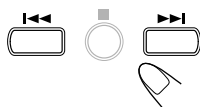

- ►►| (UP ►►|): Skips to the beginning of the next or succeeding tracks.
- |◄◄ (DOWN |◄◄): Goes back to the beginning of the current or previous tracks.

### To go to another track directly using the number buttons

**On the remote control ONLY:**

Pressing the number button(s) before or during play allows you to start playing the track number you want.

Ex.: For track number 5, press 5.

For track number 15, press +10, then 5.

For track number 20, press +10, then 10.

For track number 32, press +10, +10, +10, then 2.

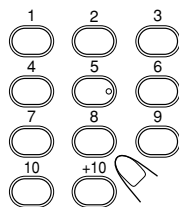

### To locate a particular point in a track

During play, press and hold ►►| or |◄◄ (or UP ►►| or DOWN |◄◄ on the unit).

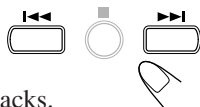

- ►►| (UP ►►|): Fast-forwards the tracks.
- |◄◄ (DOWN |◄◄): Fast-reverses the tracks.

## Programming the Track Playing Order —Program Play

You can arrange the order in which tracks play before you start playing. You can program up to 32 tracks.

**On the remote control ONLY:**

### 1 Place a disc.

- If the current source is not the CD player, press CD ►/||, then ■ before going to the next step.

### 2 Press PLAY MODE.

The PRGM (program) indicator appears on the display.

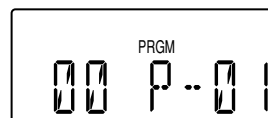

### 3 Press ►►| or |◄◄ to select the track number, then press PLAY MODE.

Track number    Program step number

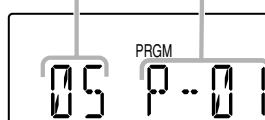

You can also use the number button(s) to select a track number.

- For the operation of the number buttons, see “To go to another track directly using the number buttons” on the left column.

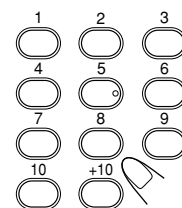
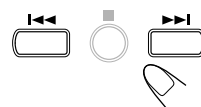

### 4 Repeat step 3 to program other tracks you want.

### 5 Press CD ►/||.

The tracks are played in the order you have programmed.



If you try to program a 33rd track “FULL” will appear on the display.

To stop playing, press ■.

Playback stops and the play mode returns to Normal Play.



### To check the program contents

You can check the program contents by pressing PLAY MODE repeatedly before or after playback.



# Playing Back Discs (continued)

## To modify the program

Press PLAY MODE repeatedly until the program step number you want to modify appears. Then follow steps **3** and **4** of the programming procedure.



To add tracks in the program, press PLAY MODE repeatedly until "00" appears as the track number. Then follow steps **3** and **4** of the programming procedure.

## To clear the program

Press PLAY MODE, then press ■ before or after playback.



The PRGM indicator disappears from the display.

- The programmed tracks are also erased in the following cases:
  - When pressing ▲ OPEN to open the disc cover.
  - When turning off the unit.
  - When changing the source.



## Repeating Tracks—Repeat Play

You can have all the tracks, the program or individual track currently playing, repeat as many times as you like.

### On the remote control ONLY:

Press REPEAT repeatedly before or during playback.



- Each time you press the button, Repeat Play changes as follows, and the following repeat indicator lights up on the display:

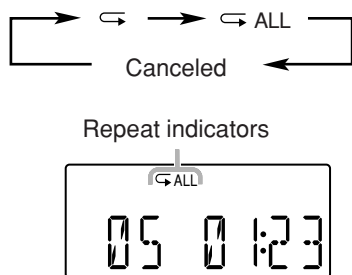

- ↶ : Repeats one track.
- ↷ ALL: In Normal Play, repeats all the tracks. In Program Play, repeats all the tracks in the program.

To cancel Repeat Play, press REPEAT repeatedly until the repeat indicator goes off.

- Repeat Play is canceled when you select another play mode (Normal, Program, or Random Play).
- In Random Play, Repeat Play cannot be selected.



## Playing at Random—Random Play

You can play the tracks at random.

### On the remote control ONLY:

Press PLAY MODE during playing.

The RANDOM indicator lights up on the display.

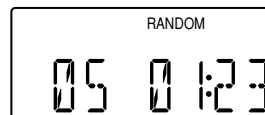

To exit from Random Play, press PLAY MODE again.

The RANDOM indicator goes off.

- It is not possible to activate the Random Play function during Program Play.



## Displaying the Remaining Time during Playback

You can display the remaining time of the current track/disc and the elapsed time of the current track/disc during playing.

### On the remote control ONLY:

Press REMAIN repeatedly.



- Each time you press the button, the display changes as follows:

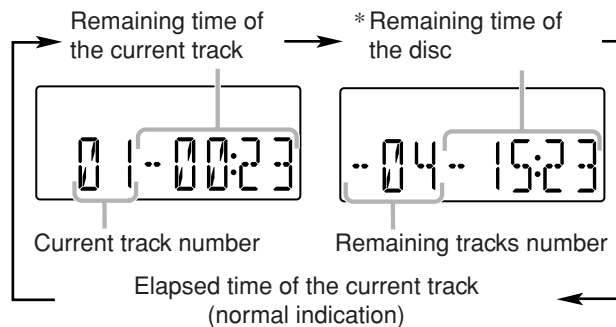

\* Remaining time of the disc will not be displayed in the following cases:

- During MP3 playback.
- During Random Play.
- During Program Play.



# Playing Back Tapes

For tape operations, use buttons on the unit.

## Playing Back a Tape

You can play back type I tapes only.

### On the unit ONLY:

#### 1 Press □/△ (stop/cassette holder open).

The cassette holder opens.

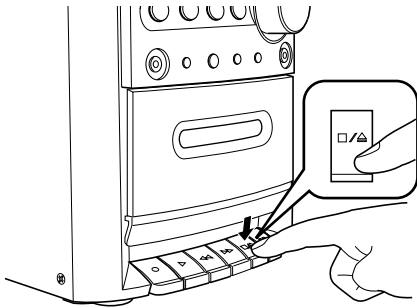

#### 2 Put a cassette in with the exposed part of the tape down.

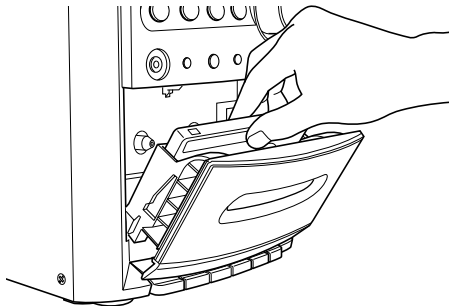

#### 3 Close the cassette holder gently.

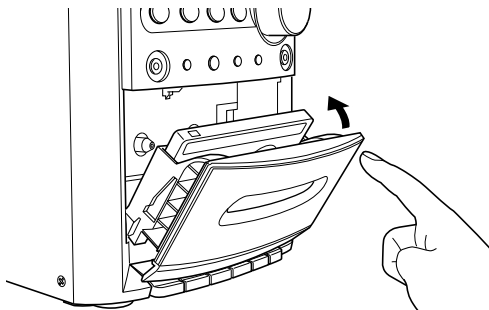

#### 4 Press TAPE.

The unit automatically turns on and the source changes to the tape deck.

- You can select to the tape by pressing TAPE on the remote control.

TAPE



#### 5 Press ▷ (play).

The tape starts playing.

- When the end of the tape is reached, playing stops.

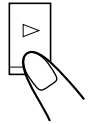

To stop playing, press □/△.



To stop playing for a moment, press |||.

To resume playing, press ||| again.

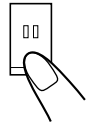

To fast forward or rewind the tape, press ▷▷ or ◀◀.

- The fast forwarding or rewinding stops at the end of the tape.

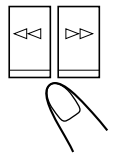

To remove the cassette, press □/△ while playback is stopped.



- DO NOT turn off the unit while playing back or recording a tape. The cassette deck or tapes may be damaged.
- The use of C-120 or longer tape is not recommended, since characteristic deterioration may occur and this tape easily jams in the pinch rollers and the capstans.
- This unit is not compatible with type II and type IV tapes.

# Using an External Equipment

---

## Listening to the External Equipment

You can listen to the external equipment such as MD recorder, cassette deck, or other auxiliary.

- First, make sure that the external equipment is properly connected to the unit. (See page 7.)

**1** Set the volume level to the minimum position.

**2** Press AUX.

“AUX” appears on the display.



**3** Start playing the external equipment.

**4** Adjust the volume level to the level you want to listen to.

To exit AUX mode, select other source.



**For operation of the external equipment**

Refer to its instructions.

## IMPORTANT:

- It should be noted that it may be unlawful to re-record pre-recorded tapes, records, or discs without the consent of the owner of copyright in the sound or video recording, broadcast or cable program and in any literary, dramatic, musical, or artistic embodied therein.
- The recording level is automatically set correctly, so it is not affected by the other sound settings. Thus, during recording you can adjust the sound you are actually listening to without affecting the recording level.
- If recordings you have made have excessive noise or static, the unit may be too close to a TV. Increase the distance between the TV and the unit.
- You can only use type I tape for recording.



- DO NOT turn off the unit while playing back or recording a tape. The cassette deck or tapes may be damaged.
- DO NOT use type II and type IV tapes since the unit is not compatible with such tapes.
- The use of C-120 or longer tape is not recommended, since characteristic deterioration may occur and this tape easily jams in the pinch rollers and the capstans.



### At the start and end of cassette tapes

There is leader tape which cannot be recorded onto. Thus, when recording from discs, FM/AM broadcasts, or external equipment, wind the leader tape first to ensure that the recording will be made without losing any music.

## To protect your recordings

Cassettes have two small tabs on the back to protect against unexpected erasure or re-recording.

To protect your recording, remove these tabs.

To re-record on a protected tape, cover the holes with adhesive tape.

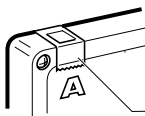

Adhesive tape

## Recording on a Tape

### On the unit ONLY:

**1 Put a recordable cassette in with the exposed part of the tape down.**



- See also page 15.

**2 Close the cassette holder gently.**

**3 Start playing the source—FM, AM, or auxiliary equipment connected to AUX jack.**

- When the source is FM or AM, tune in to the station you want to record.
- When recording from discs, see “Recording Discs—Disc Synchronized Recording” on page 18.

**4 Press  (recording).**

-  and  lock down, and the recording starts.
- REC indicator is shown on the display during recording.

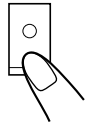

### You cannot press (recording) in the following cases:

- If no cassette is inserted.
- If a protected tape is inserted.

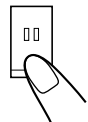

To stop recording for a moment, press .

To resume recording, press  again.



To stop recording, press /.



To remove the cassette, press / while recording is stopped.



# Recording (continued)

## Recording Discs —Disc Synchronized Recording

You can start disc play and recording at the same time.

### On the unit ONLY:

**1** Put a recordable cassette in with the exposed part of the tape down.

- See also page 15.

**2** Close the cassette holder gently.

**3** Press CD ►/|| to select the CD player as the source.



**4** Press ■ to stop the disc playback.



**5** Press ○ (recording).

The REC indicator appears on the display and the CD starts playback automatically and the recording starts.

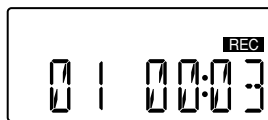
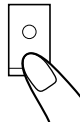

- When the end of the tape is reached, recording stops and the CD player is paused.
- If you press ○ (recording) while playing back the CD, the CD player returns to the beginning of that track and the track is recorded on the tape.



You cannot press ○ (recording) in the following cases:

- If no cassette is inserted.
- If a protected cassette is inserted.

To stop recording for a moment, press ||.

The recording is paused, but the CD playback does not stop.

To resume recording, press || again.

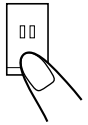

To stop recording, press □/△.

The recording stops and the CD playback is paused.



To remove the cassette, press □/△ while recording is stopped.



Daily Timer and Sleep Timer are available.

- Before using these timers, make sure the built-in clock is set correctly (see page 8).

## Using the Daily Timer

You can store three Daily timer settings and use one of settings at once.

### How the Daily Timer actually works

When the on-time comes, the unit automatically turns on and automatically turns off (standby) after 60 minutes.

- Once the timer has been set, it will be activated at the same time everyday until the timer is turned off and the timer setting remains in memory until you change it.

### Before you start...

When using "TUNER" as the source to play, make sure to select the desired station before turning off the power.

- There is a time limit in doing the following steps. If the setting is canceled before you finish, start again from step 2.

### On the remote control ONLY:

**1 Press STANDBY/ON  to turn on the unit.**



**2 Press CLOCK/TIMER repeatedly to select the Daily Timer you want to adjust and activate— Daily 1, Daily 2, Daily 3.**



Each time you press the button, the display changes as follows:

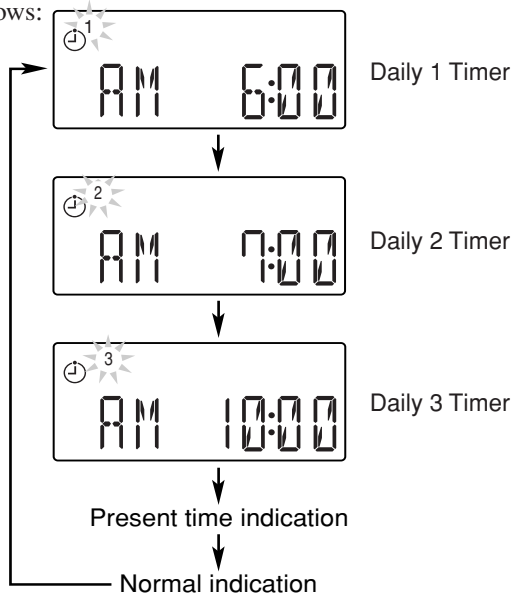



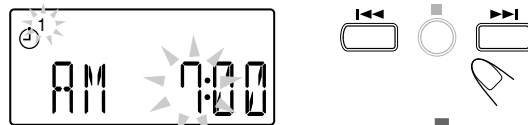

If you does not need to change the on-time setting, go to step 3.

**3 Press SET to set the on-time you want the unit to turn on.**

The hour indication starts flashing on the display.



- (1) Press  or  to set the hour, then press SET.
- (2) Press  or  to set the minute, then press SET.

If you want to change the time setting, press CANCEL.

**4 Press  or  to select the source to play.**

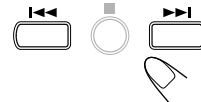

Each time you press the button, the source changes as follows:

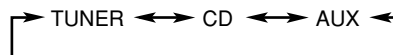

**When selecting AUX,** prepare the external equipment so that it will turn on at the on time set-on the unit. To allow this, the equipment should have the timer function.

If you want to change the time setting, press CANCEL repeatedly to return Step 3.

**5 Press SET.**

The Daily Timer number remain lit. The display return to the normal indication.



**6 Press VOLUME +/- to adjust the volume.**





**7 Press STANDBY/ON  to turn off the unit.**



# Using the Timers (continued)

## To deactivate the timer temporarily,

- (1) Press **CLOCK/TIMER** repeatedly to select the Timer Number indicator to cancel. The on-time appears and the Timer Number indicator begins to blink. 
  - (2) Press **CANCEL**. The Timer Number indicator disappears and the display returns to the normal indication. 
- You can deactivate the Daily Timer by pressing **TIMER** on the unit repeatedly until the  (timer) indicator goes off.

To activate and change the timer, repeat steps 1 to 7 on page 19.

- To activate the timer again without changing the setting, press **TIMER** on the unit repeatedly to select the timer number you want. The timer is activated and the timer number stops flashing after displaying the source and time setting on the display for a few seconds.



**If the unit is already turned on when the timer on-time comes**

The timer does not work.



**When you unplug the AC power cord or if a power failure occurs**

The timer setting remains. Set the built-in clock and activate the timer again.

## Using the Sleep Timer

With the Sleep Timer, you can fall asleep to your favorite music or radio program.

- You can set the Sleep Timer only when the unit is turned on.

### How the Sleep Timer actually works

The unit automatically turns off after the specified length of time passes.

### On the remote control ONLY:

#### 1 Press SLEEP.

The **SLEEP** indicator blinks on the display. 



- Each time you press the button, the length of time changes as follows:

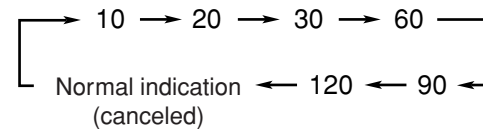

#### 2 Wait for about 5 seconds after specifying the length of time.

The **SLEEP** indicator remains lit on the display.

To check the remaining time until shut-off time, press **SLEEP** once. The remaining time until shut-off time appears for about 5 seconds.

To change the shut-off time, press **SLEEP** repeatedly until the length of time you want appears.

To cancel the setting, press **SLEEP** repeatedly until the **SLEEP** indicator goes off and display returns to the normal indication.

- Turning off the unit also cancels the Sleep Timer.



**When you set the Sleep Timer after the Daily Timer starts playing the selected source**

The unit follows the Sleep Timer setting.



**If you set the Sleep Timer while playing back or recording a tape**

Do not shut the unit off with the Sleep Timer while a tape is running. If the unit turns off while playing back or recording a tape, the cassette deck or tapes may be damaged.

# Maintenance

To get the best performance of the unit, keep your discs, tapes and mechanism clean.

## General Notes

In general, you will have the best performance by keeping your discs, tapes and the mechanism clean.

- Store discs and tapes in their cases, and keep them in cabinets or on shelves.

## Cleaning the unit

### • Stains on the unit

Should be wiped off with a soft cloth. If the unit is heavily stained, wipe it with a cloth soaked in water-diluted neutral detergent and wrung well, then wipe clean with a dry cloth.

- **Since the unit may deteriorate in quality, become damaged or have its paint peel off, be careful about the following:**
  - DO NOT wipe it with a rough cloth.
  - DO NOT wipe it too vigorously.
  - DO NOT wipe it with thinner or benzine.
  - DO NOT apply any volatile substance such as an insecticide to it.
  - DO NOT allow any rubber or plastic to remain in contact with it for a long time.

## Handling discs

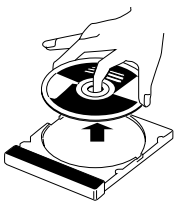

- Remove the disc from its case by holding it at the edge while pressing the center hole lightly.
- Do not touch the shiny surface of the disc, or bend the disc.
- Put the disc back in its case after use to prevent warping.

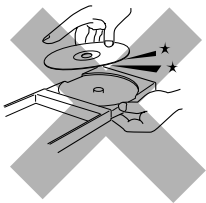

- Be careful not to scratch the surface of the disc when placing it back in its case.
- Avoid exposure to direct sunlight, temperature extremes, and moisture.

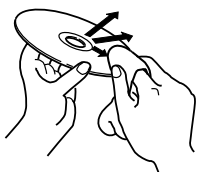

### To clean the disc

Wipe the disc with a soft cloth in a straight line from center to edge.



DO NOT use any solvent—such as conventional record cleaner, spray, thinner, or benzine—to clean the disc.

## Handling cassette tapes

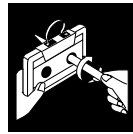

- If the tape is loose in its cassette, take up the slack by inserting a pencil in one of the reels and rotating.
- If the tape is loose, it may get stretched, cut, or caught in the cassette.

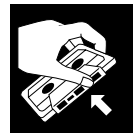

- Be careful not to touch the tape surface.



- Avoid storing tapes in any of the following places:
  - In dusty places
  - In direct sunlight or heat
  - In moist areas
  - On a TV or speaker
  - Near a magnet

## To keep the best recording and playback sound quality

You need to clean the heads.

- Clean the heads after every 10 hours of use with a wet-type head cleaning tape (available at electronic and audio shops).

When the head becomes dirty, the following symptoms will occur:

  - Sound quality is reduced.
  - Sound level decreases.
  - Sound drops out.
- Do not play dirty or dusty tapes.
- Do not touch the highly-polished head with any metallic or magnetic tools.

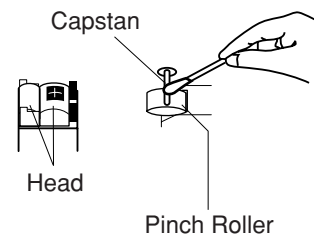

### To demagnetize the head

Turn off the unit, and use a head demagnetizer (available at electronic and audio shops).

# Troubleshooting

If you are having a problem with your unit, check this list for a possible solution before calling for service.

If you cannot solve the problem from the hints given here, or the unit has been physically damaged, call a qualified person, such as your dealer, for service.

Symptom	Possible Cause	Action
Power does not come on.	The power cord is not connected to an AC outlet.	Insert the plug into the socket.
No sound is heard.	<ul style="list-style-type: none"> <li>• Connections are incorrect or loose.</li> <li>• A pair of headphones is connected.</li> <li>• MP3 disc is recorded with “packet writing.”</li> </ul>	<ul style="list-style-type: none"> <li>• Check all connections and make corrections. (See pages 6 and 7.)</li> <li>• Unplug the headphones from the PHONES jack.</li> <li>• It cannot be played. Replace the disc.</li> </ul>
Hard to listen to broadcasts because of noise.	<ul style="list-style-type: none"> <li>• Antennas are disconnected.</li> <li>• The AM loop antenna is too close to the unit.</li> <li>• The FM antenna is not properly extended and positioned.</li> </ul>	<ul style="list-style-type: none"> <li>• Reconnect the antenna correctly and securely.</li> <li>• Change the position and direction of the AM loop antenna.</li> <li>• Extend FM antenna and orient to the best reception position.</li> </ul>
The disc does not play.	The disc is upside down.	Put the disc in with the label side up.
Specific files (tracks) on an MP3 disc are not played.	Files other than MP3 are included in the disc.	They cannot be played.
Impossible to record.	Small tabs on the back of the cassette are removed.	Cover the holes with adhesive tape.
Operations are disabled.	The built-in microprocessor has malfunctioned due to external electrical interference.	Unplug the AC power cord then plug it back in.
Unable to operate the unit by the remote control.	<ul style="list-style-type: none"> <li>• The path between the remote control and the remote sensor on the unit is blocked.</li> <li>• The batteries are exhausted.</li> <li>• You are using the remote control too far from the unit.</li> </ul>	<ul style="list-style-type: none"> <li>• Remove the obstruction.</li> <li>• Replace the batteries. (See page 6.)</li> <li>• Signals cannot reach the remote sensor. Move closer to the unit.</li> </ul>



## **Amplifier Section—CA-FSH100**

### **Output Power:**

**12.5 W per channel, min. RMS, driven into 6  $\Omega$  at 1 kHz with no more than 10% total harmonic distortion.**

Speakers/Impedance: 6  $\Omega$  – 16  $\Omega$

### **Tuner**

FM tuning range: 87.5 MHz—108.0 MHz

AM tuning range: 530 kHz—1 710 kHz

### **CD player**

Dynamic range: 85 dB

Signal-to-noise ratio: 85 dB

Wow and flutter: Immeasurable

### **Cassette deck**

Frequency response:

Normal (type I): 100 Hz—10 000 Hz

Wow and flutter: 0.35 % (WRMS)

### **General**

Power requirement: AC 120 V  $\sim$ , 60 Hz

Power consumption: 38 W (at operation)

2 W (on standby)

Dimensions (W/H/D) (approx.):

144 mm x 255 mm x 277 mm

(5 <sup>11</sup>/<sub>16</sub> in. x 10 <sup>1</sup>/<sub>16</sub> in. x 10 <sup>15</sup>/<sub>16</sub> in.)

Mass (approx.): 2.9 kg (6.4 lbs)

### **Supplied accessories**

See page 6.

## **Speaker Section—SP-FSH100**

Type: Full range bass-reflex type

Speakers: 10 cm cone x1

Power handling capacity: 12.5 W

Impedance: 6  $\Omega$

Frequency range: 100 Hz to 15 kHz

Dimensions (W/H/D) (approx.):

130 mm x 257 mm x 151 mm

(5 <sup>1</sup>/<sub>8</sub> in. x 10 <sup>1</sup>/<sub>8</sub> in. x 6 in.)

Mass (approx.): 1.5 kg (3.3 lbs) each



# LIMITED WARRANTY

AUDIO-1

JVC COMPANY OF AMERICA warrants this product and all parts thereof, except as set forth below ONLY TO THE ORIGINAL PURCHASER AT RETAIL to be FREE FROM DEFECTIVE MATERIALS AND WORKMANSHIP from the date of original retail purchase for the period as shown below. ("The Warranty Period")

PARTS	<b>1 YR</b>	LABOR	<b>1 YR</b>
-------	-------------	-------	-------------

THIS LIMITED WARRANTY IS VALID ONLY IN THE FIFTY (50) UNITED STATES, THE DISTRICT OF COLUMBIA AND IN COMMONWEALTH OF PUERTO RICO.

**WHAT WE WILL DO:**

If this product is found to be defective, JVC will repair or replace defective parts at no charge to the original owner. Such repair and replacement services shall be rendered by JVC during normal business hours at JVC authorized service centers. Parts used for replacement are warranted only for the remainder of the Warranty Period. All products and parts thereof may be brought to a JVC authorized service center on a carry-in basis except for Television sets having a screen size 25 inches and above which are covered on an in-home basis.

**WHAT YOU MUST DO FOR WARRANTY SERVICE:**

Return your product to a JVC authorized service center with a copy of your bill of sale. For your nearest JVC authorized service center, please call toll free: (800) 537-5722.

If service is not available locally, box the product carefully, preferably in the original carton, and ship, insured, with a copy of your bill of sale plus a letter of explanation of the problem to the nearest JVC Factory Service Center, the name and location of which will be given to you by the toll-free number.

If you have any questions concerning your JVC Product, please contact our Customer Relations Department.

**WHAT IS NOT COVERED:**

This limited warranty provided by JVC does not cover:

1. Products which have been subject to abuse, accident, alteration, modification, tampering, negligence, misuse, faulty installation, lack of reasonable care, or if repaired or serviced by anyone other than a service facility authorized by JVC to render such service, or if affixed to any attachment not provided with the products, or if the model number or serial number has been altered, tampered with, defaced or removed;
2. Initial installation and installation and removal for repair;
3. Operational adjustments covered in the Owner's Manual, normal maintenance, video and audio head cleaning;
4. Damage that occurs in shipment, due to act of God, and cosmetic damage;
5. Signal reception problems and failures due to line power surge;
6. Video Pick-up Tubes/CCD Image Sensor, Cartridge, Stylus (Needle) are covered for 90 days from the date of purchase;
7. Accessories
8. Batteries (except that Rechargeable Batteries are covered for 90 days from the date of purchase);

There are no express warranties except as listed above.

THE DURATION OF ANY IMPLIED WARRANTIES, INCLUDING THE IMPLIED WARRANTY OF MERCHANTABILITY, IS LIMITED TO THE DURATION OF THE EXPRESS WARRANTY HEREIN.

JVC SHALL NOT BE LIABLE FOR THE LOSS OF USE OF THE PRODUCT, INCONVENIENCE, LOSS OR ANY OTHER DAMAGES, WHETHER DIRECT, INCIDENTAL OR CONSEQUENTIAL (INCLUDING, WITHOUT LIMITATION, DAMAGE TO TAPES, RECORDS OR DISCS) RESULTING FROM THE USE OF THIS PRODUCT, OR ARISING OUT OF ANY BREACH OF THIS WARRANTY. ALL EXPRESS AND IMPLIED WARRANTIES, INCLUDING THE WARRANTIES OF MERCHANTABILITY AND FITNESS FOR PARTICULAR PURPOSE, ARE LIMITED TO THE WARRANTY PERIOD SET FORTH ABOVE.

Some states do not allow the exclusion of incidental or consequential damages or limitations on how long an implied warranty lasts, so these limitations or exclusions may not apply to you. This warranty gives you specific legal rights and you may also have other rights which vary from state to state.

JVC COMPANY OF AMERICA                      1700 Valley Road  
 DIVISION OF JVC AMERICAS CORP.            Wayne, NJ 07470

REFURBISHED PRODUCTS CARRY A SEPARATE WARRANTY, THIS WARRANTY DOES NOT APPLY. FOR DETAILS OF REFURBISHED PRODUCT WARRANTY, PLEASE REFER TO THE REFURBISHED PRODUCT WARRANTY INFORMATION PACKAGED WITH EACH REFURBISHED PRODUCT.

**For customer use:**

Enter below the Model No. which is located either on the rear, bottom or side of the cabinet. Retain this information for future reference.

Model No. :	Serial No. :
Purchase data :	Name of dealer :

# Authorized Service Centers

---

QUALITY **JVC**<sup>®</sup> SERVICE

*HOW TO LOCATE YOUR JVC SERVICE CENTER*

**TOLL FREE: 1 (800) 537-5722**

**<http://www.jvc.com>**

Dear Customer,

In order to receive the most satisfaction from your purchase, please read the instruction booklet before operating the unit. In the event that repairs are necessary, please call 1 (800)537-5722 for your nearest authorized servicer or visit our website at **[www.JVC.com](http://www.JVC.com)**

Remember to retain your Bill of Sale for Warranty Service.

---

**Do not service the television yourself**

---

## **Caution**

To prevent electrical shock, do not open the cabinet. There are no user serviceable parts inside. Please refer to qualified service personnel for repairs.

## **Accessories**

To purchase accessories for your JVC product, please call toll free: 1 (800)882-2345 or on the web at **[www.JVC.com](http://www.JVC.com)**

---

